

SONY

2-663-603-11(1)

CD Radio Cassette-Corder

Operating Instructions

US

Owner's Record

The model number is located at the bottom and the serial number is located in the battery compartment. Record the serial number in the space provided below. Refer to them whenever you call upon your Sony dealer regarding this product.
Model No. _____ Serial No. _____

CFD-G505

© 2006 Sony Corporation Printed in China
http://www.sony.net/

WARNING

To reduce the risk of fire or electric shock, do not expose this apparatus to rain or moisture.

To reduce the risk of fire, do not cover the ventilation of the apparatus with newspapers, tablecloths, curtains, etc. And do not place lighted candles on the apparatus.

To reduce the risk of fire or electric shock, do not place objects filled with liquids, such as vases, on the apparatus.

Connect the apparatus to an easily accessible AC outlet. Should you notice an abnormality in the apparatus, disconnect the main plug from the AC outlet immediately.

Do not install the appliance in a confined space, such as a bookcase or built-in cabinet.

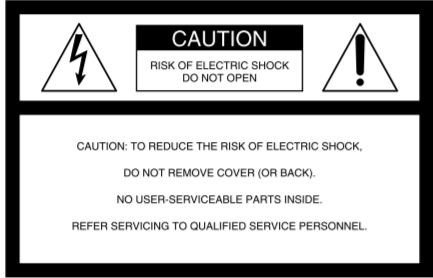

This symbol is intended to alert the user to the presence of uninsulated "dangerous voltage" within the product's enclosure that may be of sufficient magnitude to constitute a risk of electric shock to persons.



This symbol is intended to alert the user to the presence of important operating and maintenance (servicing) instructions in the literature accompanying the appliance.

Power sources

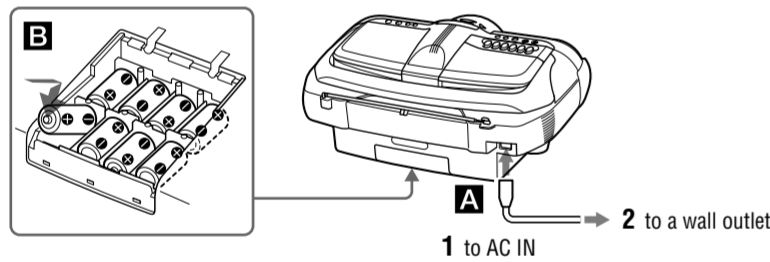

Connect the AC power cord **A** or insert eight R20 (size D) batteries (not supplied) into the battery compartment **B**.

- Notes**
- Replace the batteries when the OPR/BATT indicator dims or when the unit stops operating. Replace all the batteries with new ones. Before you replace the batteries, be sure to take out the CD from the unit.
 - To use the unit on batteries, disconnect the AC power cord from the unit.
 - When you operate the unit on batteries, you cannot turn on the unit using the remote.

Preparing the remote

Insert two R03 (size AAA) batteries (not supplied).

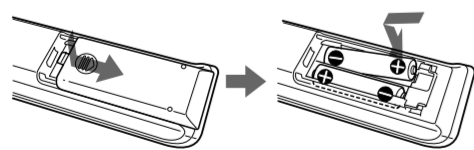

Replacing batteries

With normal use, the batteries should last for about six months. When the remote no longer operates the unit, replace all the batteries with new ones.

CAUTION

The use of optical instruments with this product will increase eye hazard.

Information

For customers in the USA

This equipment has been tested and found to comply with the limits for a Class B digital device, pursuant to Part 15 of the FCC Rules. These limits are designed to provide reasonable protection against harmful interference in a residential installation. This equipment generates, uses, and can radiate radio frequency energy and, if not installed and used in accordance with the instructions, may cause harmful interference to radio communications. However, there is no guarantee that interference will not occur in a particular installation. If this equipment does cause harmful interference to radio or television reception, which can be determined by turning the equipment off and on, the user is encouraged to try to correct the interference by one or more of the following measures:

- Reorient or relocate the receiving antenna.
- Increase the separation between the equipment and receiver.
- Connect the equipment into an outlet on a circuit different from that to which the receiver is connected.
- Consult the dealer or an experienced radio/TV technician for help.

This device complies with Part 15 of the FCC rules. Operation is subject to the following two conditions: (1) This device may not cause harmful interference, and (2) this device must accept any interference received, including interference that may cause undesired operation.

You are cautioned that any changes or modifications not expressly approved in this manual could void your authority to operate this equipment.

Notes on DualDiscs

A DualDisc is a two sided disc product which mates DVD recorded material on one side with digital audio material on the other side. However, since the audio material side does not conform to the Compact Disc (CD) standard, playback on this product is not guaranteed.

Music discs encoded with copyright protection technologies

This product is designed to playback discs that conform to the Compact Disc (CD) standard. Recently, various music discs encoded with copyright protection technologies are marketed by some record companies. Please be aware that among those discs, there are some that do not conform to the CD standard and may not be playable by this product.

For customers in the USA

Please register this product on line at <http://www.sony.com/productregistration>. Proper registration will enable us to send you periodic mailings about new product, services and other important announcements. Registering your product will also allow us to contact you in the unlikely event that the product needs adjustment or modification. Thank you.

Basic Operations

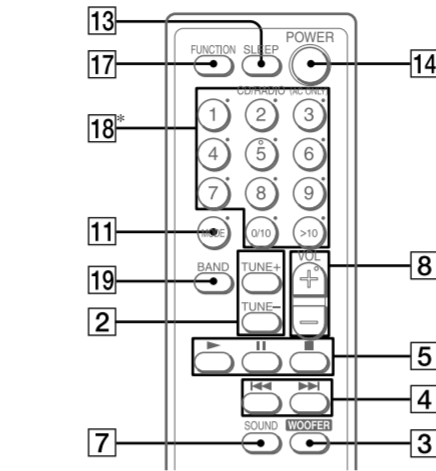
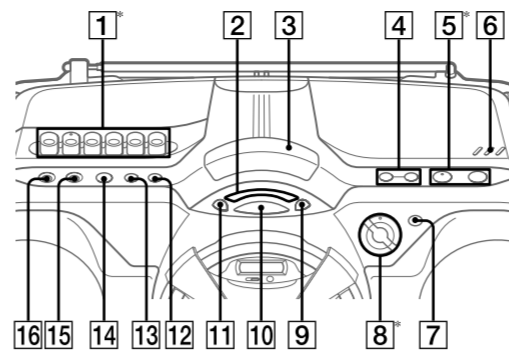

*VOL + [8], [11] [5], [1] and 5 [8] on the remote have a tactile dot.

To	Press
Pause playback	[11] on the unit ([11] on the remote) [5]. To resume play, press it again.
Stop playback	[5].
Go to the next track	[4].
Go back to the previous track	[4].
Locate a point while listening to the sound	[4] (forward) or [4] (backward) while playing and hold it until you find the point.
Locate a point while observing the display	[4] (forward) or [4] (backward) in pause and hold it until you find the point.
Locate a specific track directly	The number button [8] of the track on the remote.
Remove the CD	[6].

Tip
When you locate a track numbered over 10, press >10 [8] on the remote first, then the corresponding number buttons [8] on the remote. Example: To play track number 23, press >10 first, then 2 and 3.

Note
You cannot locate a specific track if "SHUF" or "PGM" is lit in the display. Turn off the indication by pressing [5].

Listening to the radio

- Press RADIO BAND•AUTO PRESET [10] on the unit (BAND [19] on the remote) repeatedly. Each time you press the button, the indication changes as follows: "FM" → "AM"
- Hold down TUNE + or - [2] until the frequency digits begin to change in the display. The unit automatically scans the radio frequencies and stops when it finds a clear station. If you cannot tune in a station, press TUNE + or - [2] repeatedly to change the frequency step by step. When an FM stereo broadcast is received, "ST" appears.

Tip
If the FM broadcast is noisy, press MODE [11] until "Mono" appears in the display and the radio will play in monaural.

Playing a tape

Use buttons on the unit for the operation.

- Press [1] on the unit, and insert the tape into the tape compartment with the side you want to play facing upward. Use TYPE I (normal) tape only. Close the compartment. Make sure there is no slack in the tape to avoid damaging the tape or the unit.

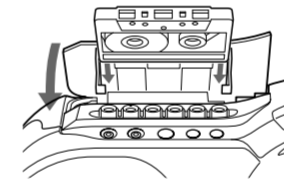

- Press [1] on the unit. The unit starts playing.

To	Press
Pause playback	[11] [1] on the unit. To resume play, press it again.
Stop playback	[5] [1] on the unit.
Fast-forward or rewind	[1] or [1] (fast forward or rewind) [1] on the unit.
Eject the cassette	[1] [1] on the unit.

Recording on a tape

Use buttons on the unit for the operation.

- Press [1] on the unit to open the tape compartment and insert a blank tape with the side you want to record on facing upward. Use TYPE I (normal) tape only. Close the compartment.
- Select the program source you want to record. To record from the CD player, press [5] on the unit and place a CD. To record from the radio, tune in the station you want (see "Listening to the radio").
- Press [1] on the unit to start recording ([1] is depressed automatically).

To	Press
Pause recording	[11] [1] on the unit. Press the button again to resume recording.
Stop recording	[5] [1] on the unit.

Before using the unit

To turn on/off the power
Press POWER [14].

To adjust the volume
Press VOL +, - [8].

To listen through headphones
Connect the headphones to the (headphones) jack [16].

To select the sound characteristic
Press SOUND [7] repeatedly to select the audio emphasis you want.

Choose	To get
---	Powerful, clean sounds, emphasizing low and high range audio
---	Light, bright sounds emphasizing high and middle range audio
---	Percussive sounds, emphasizing bass audio
---	The presence of vocals, stressing middle range audio
---	The whole dynamic range for music such as classical music

To reinforce the bass sound
Press POWER DRIVE WOOFER (WOOFER on the remote) [3] to select [WOOFER] or [WOOFER] on the display. [WOOFER] is more effective. When the WOOFER function works, the ring on the front panel lights up. To return to normal sound, press the button repeatedly until the indication disappears from the display.

Notes
• While the sleeping timer is on, the ring does not light, even if the WOOFER function is used.
• When you use the headphones, the WOOFER function does not work.

Playing a CD

- Press [6] on the unit, and place a disc with the label side up on the CD compartment. To close the CD compartment, press [6] on the unit.

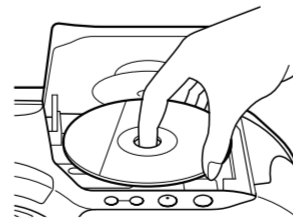

- Press [11] on the unit ([11] on the remote) [5]. The unit plays all the tracks once.

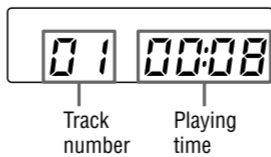

Specifications

AUDIO POWER SPECIFICATIONS
POWER OUTPUT AND TOTAL HARMONIC DISTORTION
With 3.2-ohm loads, both channels driven from 150 - 10 000 Hz; rated 3 W per channel; minimum RMS power, with no more than 10 % total harmonic distortion in AC operation.
Woofer with 4-ohm loads, driven at 50 - 150 Hz; rated 6 W minimum RMS power, with no more than 10 % total harmonic distortion in AC operation.

Other specifications

CD player section

System
Compact disc digital audio system
Laser diode properties
Emission duration: Continuous
Laser output: Less than 44.6 μW
(This output is the value measured at a distance of about 200 mm from the objective lens surface on the optical pick-up block with 7 mm aperture.)
Number of channels
2
Frequency response
20 - 20 000 Hz +1/-2 dB
Wow and flutter
Below measurable limit

Radio section

Frequency range
FM: 87.5 - 108 MHz
AM: 530 - 1 710 kHz
Antennas
FM: Telescopic antenna
AM: Built-in ferrite bar antenna

Cassette-corder section

Recording system
4-track 2 channel stereo
Fast winding time
Approx. 120 s (sec.) with Sony cassette C-60
Frequency response
TYPE I (normal): 70 - 13 000 Hz

General

Speaker
Full range: 10 cm (4 in.) dia., 3.2 Ω cone type (2)
Woofer: 10 cm (4 in.) dia., 4 Ω cone type (1)
Input
LINE IN jack (stereo minijack): Minimum input level 330 mV
Outputs
Headphones jack (stereo minijack)
For 16 - 68 Ω impedance headphones
Power output
4 W + 4 W (at 3.2 Ω, 10% harmonic distortion)
Woofer:
12 W (at 4 Ω, 10% harmonic distortion)
Power requirements
For CD radio cassette-corder:
120 V AC, 60 Hz
12 V DC, 8 R20 (size D) batteries
For remote control:
3 V DC, 2 R03 (size AAA) batteries
Power consumption
AC 30 W

Battery life
For CD radio cassette-corder:
FM recording
Sony R20P: approx. 6 h
Sony alkaline LR20: approx. 18 h
Tape playback
Sony R20P: approx. 1.5 h
Sony alkaline LR20: approx. 6 h
CD playback
Sony R20P: approx. 1 h
Sony alkaline LR20: approx. 4 h

Dimensions
Approx. 530 × 241 × 369 mm (w/h/d)
(20 1/8 × 9 1/2 × 14 3/8 inches) (incl. projecting parts)
Mass
Approx. 8.0 kg (17 lb. 10 oz) (incl. batteries)
Supplied accessories
AC power cord (1)
Remote control (1)

Design and specifications are subject to change without notice.

Optional accessories

Sony MDR headphones series

Other Operations

Using the display

You can check information about the CD using the display.

To check the total track number and playing time of the CD

Press DISPLAY•ENTER•MEMORY **[9]** on the unit while the CD is stopped.

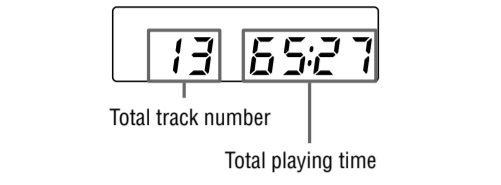

To check the remaining time

Press DISPLAY•ENTER•MEMORY **[9]** on the unit while playing a CD. The display changes as follows:

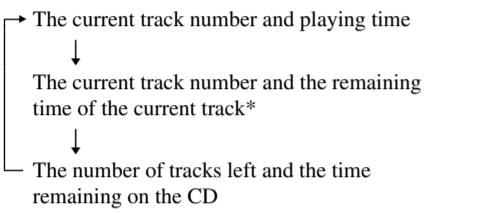

*For a track whose number is more than 20, the remaining time appears as “- : - : -” in the display.

Playing tracks repeatedly

(Repeat Play)

You can play tracks repeatedly in normal, Shuffle or Program Play modes.

- Press **■ [5]**.

“Cd” appears in the display.

- Proceed as follows.

To repeat	Do this
A single track	1 Press MODE [1] until “REP 1” appears. 2 Press ◀◀ or ▶▶ [4] to select the track that you want to repeat. 3 Press ▶▶ [5] on the unit.
All tracks on the CD	1 Press MODE [1] until “REP ALL” appears. 2 Press ▶▶ [5] on the unit.
Tracks in random order	1 Press MODE [1] until “SHUF” and “REP” appear. 2 Press ▶▶ [5] on the unit.
Programed tracks	1 Press MODE [1] until “REP” and “PGM” appear. 2 Program tracks (see step 3 of “Creating your own program”). 3 Press ▶▶ [5] on the unit.

On the remote

- Use **▶ [5]** instead of **▶▶ [5]**.
- After you have selected “REP 1”, press the number buttons **[8]** to select the track.

To cancel Repeat Play

Press MODE **[1]** until “REP” disappears from the display.

Playing tracks in random order (Shuffle Play)

You can play tracks in random order.

- Press **■ [5]**.

“Cd” appears in the display.

- Press MODE **[1]** until “SHUF” appears in the display.

- Press **▶▶ [5]** on the unit to start Shuffle Play.

On the remote

Use **▶ [5]** instead of **▶▶ [5]**.

To cancel Shuffle Play

Press MODE **[1]** until “SHUF” disappears from the display.

Tip
During Shuffle Play, you cannot select the previous track by pressing **◀◀ [4]**.

Creating your own program (Program Play)

You can arrange the playing order of up to 20 tracks on a CD.

- Press **■ [5]**.

“Cd” appears in the display.

- Press MODE **[1]** until “PGM” flashes in the display.

- Press **◀◀** or **▶▶ [4]** then press DISPLAY•ENTER•MEMORY **[9]** on the unit for the tracks you want to program in the order you want.

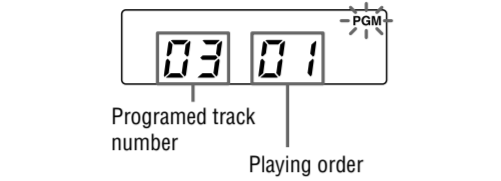

- Press **▶▶ [5]** on the unit to start Program Play.

On the remote

- Use **▶ [5]** instead of **▶▶ [5]**.
- After you have selected “PGM”, press the number buttons **[8]** for the tracks you want to program in the order you want.

To cancel Program Play

Press MODE **[1]** until “PGM” disappears from the display.

To check the order of tracks before play

Press DISPLAY•ENTER•MEMORY **[9]** on the unit. Every time you press the button, the track number appears in the programed order.

To change the current program

Press **■ [5]** once if the CD is stopped and twice if the CD is playing. The current program will be erased. Then create a new program following the programing procedure.

Tips

- You can play the same program again, since the program is saved until you open the CD compartment.
- You can record your own program. After you have created the program, insert a blank tape and press **● [1]** on the unit to start recording.

Presetting radio stations

You can store radio stations into the unit’s memory. You can preset up to 30 radio stations, 20 for FM and 10 for AM in any order.

- Press RADIO BAND•AUTO PRESET **[10]** on the unit to select the band.

- Hold down RADIO BAND•AUTO PRESET **[10]** on the unit for 2 seconds until “AUTO” flashes in the display.

- Press DISPLAY•ENTER•MEMORY **[9]** on the unit.

The stations are stored in memory from the lower frequencies to the higher ones.

If a station cannot be preset automatically

You need to preset a station with a weak signal manually.

- Press RADIO BAND•AUTO PRESET **[10]** on the unit to select the band.

- Tune in a station you want.

- Hold down DISPLAY•ENTER•MEMORY **[9]** on the unit for 2 seconds until the preset number flashes in the display.

- Press PRESET + or – **[4]** on the unit until the preset number you want for the station flashes in the display.

- Press DISPLAY•ENTER•MEMORY **[9]** on the unit.

The new station replaces the old one.

On the remote

- Press BAND **[8]** until the band you want appears in the display.

- Tune in a station you want.

- Hold down the number buttons **[8]** that you want to preset the new station on for about 2 seconds.

To select the preset number over 10, press >10 **[8]** first, then the corresponding number buttons **[8]**.

You need to hold down the last number button to enter for about 2 seconds.

(Example: To select 12, press >10 and 1 first, then hold down 2 for about 2 seconds.)

Tip

The preset radio stations remain in memory even if you unplug the AC power cord or remove the batteries.

Playing preset radio stations

- Press RADIO BAND•AUTO PRESET **[10]** on the unit to select the band.

- Press PRESET + or – **[4]** on the unit to tune in the stored station.

On the remote

- Press BAND **[8]**.

- Press the number buttons **[8]** to tune in the stored station.

To tune in a preset station over 10, press >10 **[8]** first, then corresponding number buttons **[8]**.

(Example: To tune in a preset station 12, press >10 and 1 first, and then press 2.)

Falling asleep to music

- Play the music source you want.

- Press SLEEP **[13]** to display “SLEEP”.

- Press SLEEP **[13]** to select the minutes until the unit goes off automatically.

Each time you press the button, the indication changes as follows:

“60” → “90” → “120” → “OFF” → “10” → “20” → “30”.

If 4 seconds have passed after you pressed SLEEP **[13]**, the minutes in the display are entered.

When the preset time has passed, the unit goes off automatically.

To cancel the sleep function

Press POWER **[14]** to turn off the power.

Note

When you are playing a tape using this function: If the tape length of one side is longer than the set time, the unit will not go off until the tape reaches the end.

Connecting optional component

You can enjoy the sound from a PC, TV, VCR, portable digital music player, etc. through the speakers of this unit.

Be sure to turn off the power of each component before making any connections.

For details, refer to the instruction manual of the component to be connected.

- Connect the LINE IN jack **[15]** on the unit to the line output jack of the portable digital music player or other components using an audio connecting cable* (not supplied).

* For a PC: use a cable which fills the connector of your PC. For a TV or VCR: use a cable with a stereo-mini plug on one end and two phono plugs on the other end. For a portable digital music player: use a cable with a stereo-mini plug on both ends.

- Turn the unit and the connected component on.

- Press LINE **[12]** on the unit and start playing sound on the connected component.

The sound from the connected component is output from the speakers.

Recording the sound from the connected component

- Insert a blank cassette.

- Press LINE **[12]** on the unit to display “LInE”.

- Press **● [1]** on the unit.

Recording starts.

- Play the optional component connected to the LINE IN jack **[15]** on the unit.

Note

Connect the cables securely to avoid any malfunction.

Precautions

Discs that this unit CAN play

- Audio CD

- CD-R/CD-RW (CD-DA*)

* CD-DA is the abbreviation for Compact Disc Digital Audio. It is a recording standard used for Audio CDs.

Discs that this unit CANNOT play

- CD-R/CD-RW other than those recorded in music CD format

- CD-R/CD-RW of poor recording quality, CD-R/CD-RW that has scratches or are dirty, or CD-R/CD-RW recorded with an incompatible recording device

- CD-R/CD-RW which is finalized incorrectly

Notes on discs

- Before playing, clean the CD with a cleaning cloth. Wipe the CD from the center out. If there is a scratch, dirt or fingerprints on the CD, it may cause tracking error.



- Do not use solvents such as benzene, thinner, commercially available cleaners or anti-static spray intended for vinyl LPs.
- Do not expose the CD to direct sunlight or heat sources such as hot air ducts, nor leave it in a car parked in direct sunlight as there can be a considerable rise in temperature inside the car.
- Do not stick paper or sticker on the CD, nor scratch the surface of the CD.
- After playing, store the CD in its case.

On safety

- As the laser beam used in the CD player section is harmful to the eyes, do not attempt to disassemble the casing. Refer servicing to qualified personnel only.
- Should any solid object or liquid fall into the unit, unplug the unit, and have it checked by qualified personnel before operating it any further.
- Discs with non-standard shapes (e.g., heart, square, star) cannot be played on this unit. Attempting to do so may damage the unit. Do not use such discs.

On power sources

- For AC operation, use the supplied AC power cord; do not use any other type.
- The unit is not disconnected from the AC power source (mains) as long as it is connected to the wall outlet, even if the unit itself has been turned off.
- Unplug the unit from the wall outlet when it is not used for an extended period of time.
- When the batteries are not to be used, remove them to avoid damage that can be caused by battery leakage or corrosion.
- The nameplate indicating operating voltage, power consumption, etc. is located at the bottom.

On placement

- Do not leave the unit in a location near heat sources, in a place subject to direct sunlight, excessive dust or mechanical shock or in a car subject to the direct rays of the sun.
- Do not place the unit on an inclined or unstable place.
- Do not place anything within 10 mm of the side of the cabinet. The ventilation holes must be unobstructed for the unit to operate properly and prolong the life of its components.
- Since a strong magnet is used for the speakers, keep personal credit cards using magnetic coding or spring-wound watches away from the unit to prevent possible damage from the magnet.

On operation

- If the unit is brought directly from a cold to a warm location, or is placed in a very damp room, moisture may condense on the lens inside the CD player section. Should this occur, the unit will not operate properly. In this case, remove the CD and wait about an hour for the moisture to evaporate.
- If the unit has not been used for a long time, set it in the playback mode to warm it up for a few minutes before inserting a cassette.

Notes on cassettes

- Break off the cassette tab from side A or B to prevent accidental recording. If you want to reuse the tape for recording, cover the broken tab with adhesive tape.

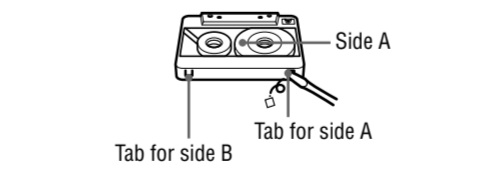

- The use of a cassette with more than 90 minutes of play time is not recommended except for long, continuous recording or playback.

Cleaning the cabinet

- Clean the cabinet, panel and controls with a soft cloth slightly moistened with a mild detergent solution. Do not use any type of abrasive pad, scouring powder, or solvent, such as alcohol or benzene.

If you have any questions or problems concerning your unit, please consult your nearest Sony dealer.

Troubleshooting

General

The power is not on.

- Connect the AC power cord to the wall outlet securely.
- Make sure the batteries are inserted correctly.
- Replace all the batteries with new ones if they are weak.
- You cannot turn on the unit with the remote when you operate the unit on batteries.

There is no audio.

- Make sure the function you want to use appears in the display window.
- Unplug the headphones when listening through speakers.

Noise is heard.

- Someone is using a portable telephone or other equipment that emits radio waves near the unit. → Move the portable telephone, etc., away from the unit.

CD player

The CD does not play or “no dISC” is displayed even when a CD is in place.

- Place the CD with the label surface up.
- Clean the CD.
- Take out the CD and leave the CD compartment open for about an hour to dry moisture condensation.
- The CD-R/CD-RW is blank.
- There is a problem with the quality of the CD-R/ CD-RW, recording device or application software.
- Replace all the batteries with new ones if they are weak.

The sound drops out.

- Reduce the volume.
- Clean the CD, or replace it if the CD is badly damaged.
- Place the unit in a location free from vibration.
- Clean the lens with a commercially available blower.
- The sound may drop out or noise may be heard when using poor quality CD-R/CD-RW or if there is a problem with the recording device or application software.

Radio

Reception is poor.

- Reorient the antenna to improve FM reception.

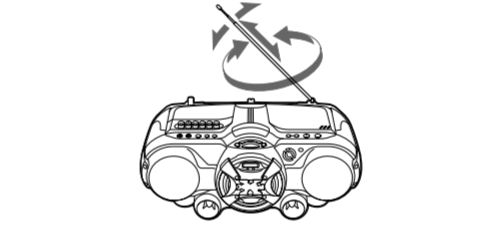

- Reorient the unit itself to improve AM reception.

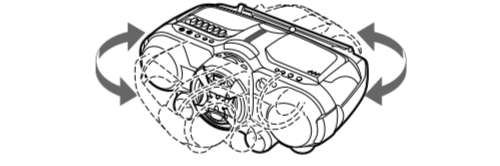

The audio is weak or has poor quality.

- Replace all the batteries with new ones if they are weak.
- Move the unit away from the TV.
- If you are using the remote while listening to AM radio, noise may be heard.

The picture of your TV becomes unstable.

- If you are listening to an FM program near the TV with an indoor antenna, move the unit away from the TV.

Tape player

The tape does not move when you press an operation button.

- Close the cassette compartment securely.

The ● button [1] does not function or the tape does not play or record.

- Make sure the safety tab on the cassette is in place.

Poor or distorted playback, recording or erasing quality.

- Clean the heads by using dry- or wet-type cleaning cassette (available separately) after every 10 hours of use, before you start an important recording, or after playing an old tape. Failure to clean the tape heads can cause degraded sound quality or an inability of the unit to record or play tapes. For details, refer to the instructions of the cleaning cassette.
- The TYPE II (high position) or TYPE IV (metal) tape is being used. Use TYPE I (normal) tape only.
- Demagnetize the heads using a commercially available tape head demagnetizer.
- Replace all the batteries with new ones if they are weak.

Remote

The remote does not function.

- Replace all the batteries in the remote with new ones if they are weak.
- Make sure that you are pointing the remote at the remote sensor on the unit.
- Remove any obstacles in the path of the remote and the unit.
- Make sure the remote sensor is not exposed to strong light such as direct sunlight or fluorescent lamp light.
- Move closer to the unit when using the remote.

After trying the remedies, if you still have problems, unplug the AC power cord or remove all the batteries. After all the indications in the display disappear, plug the AC power cord or insert the batteries again. If the problem persists, please consult your nearest Sony dealer.